

Data Sheet



Article number: 204040M863A1SK

Description: E+G levelling foot
GN 40-40-M8-63-A1-SK

Note: SK With nut, External hexagon at the bottom

Measures

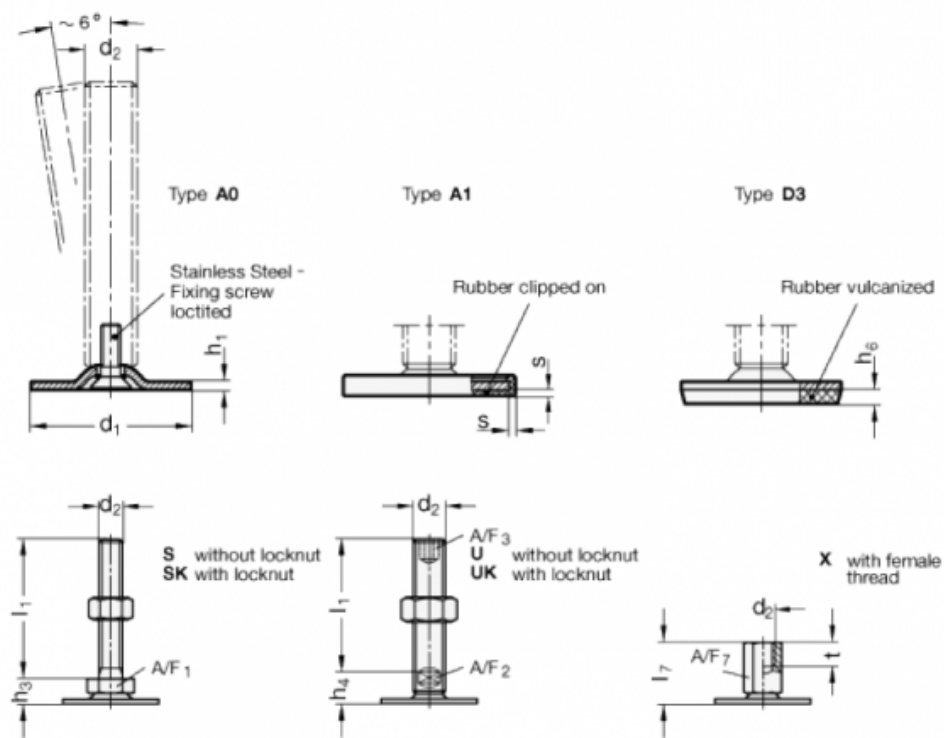

A/F1	= 17
d1	= 40
d2	= M8
h1	= 2
h3	= 11
h6	=
l1	= 63
s	= 1.5